

100V N-Ch Power MOSFET

V_{DS}		100	V
$R_{DS(on),typ}$	$V_{GS}=10V$	15	m
$R_{DS(on),typ}$	$V_{GS}=4.5V$	20	m
I_D (Silicon Limited)		38.7	A

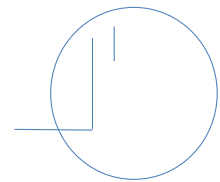

Part Number	Package	Marking
HGD170N10AL	TO-252	GD170N10AL
HGI170N10AL	TO-251	GI170N10AL

Absolute Maximum Ratings at $T_J=25^{\circ}\text{C}$ (unless otherwise specified)

Parameter	Symbol	Conditions	Value	Unit
Continuous Drain Current (Silicon Limited)	I_D	$T_C=25^{\circ}\text{C}$	39	A
		$T_C=100^{\circ}\text{C}$	24	
Drain to Source Voltage	V_{DS}	-	100	V
Gate to Source Voltage	V_{GS}	-	± 20	V
Pulsed Drain Current	I_{DM}	-	160	A
Avalanche Energy, Single Pulse	E_{AS}	$L=0.4\text{mH}, T_C=25^{\circ}\text{C}$	45	mJ
Power Dissipation	P_D	$T_C=25^{\circ}\text{C}$	52	W
Operating and Storage Temperature	T_J, T_{stg}	-	-55 to 150	$^{\circ}\text{C}$

Absolute Maximum Ratings

Parameter	Symbol	Max	Unit
Thermal Resistance Junction-Ambient	R_{JA}	50	$^{\circ}\text{C/W}$
Thermal Resistance Junction-Case	R_{JC}	2.4	$^{\circ}\text{C/W}$

Electrical Characteristics at $T_J=25^\circ\text{C}$ (unless otherwise specified)
Static Characteristics

Parameter	Symbol	Conditions	Value			Unit
			min	typ	max	
Drain to Source Breakdown Voltage	$V_{(BR)DSS}$	$V_{GS}=0V, I_D=250\text{ A}$	100	-	-	V
Gate Threshold Voltage	$V_{GS(th)}$	$V_{GS}=V_{DS}, I_D=250\text{ A}$	1.4	2.0	2.4	
Zero Gate Voltage Drain Current	I_{DSS}	$V_{GS}=0V, V_{DS}=100V, T_J=25^\circ\text{C}$	-	-	1	A
		$V_{GS}=0V, V_{DS}=100V, T_J=100^\circ\text{C}$	-	-	100	
Gate to Source Leakage Current	I_{GSS}	$V_{GS}=\pm 20V, V_{DS}=0V$	-	-	± 100	nA
Drain to Source on Resistance	$R_{DS(on)}$	$V_{GS}=10V, I_D=15A$	-	15	17	m
		$V_{GS}=4.5V, I_D=10A$	-	20	26	
Transconductance	g_{fs}	$V_{DS}=5V, I_D=15A$	-	42	-	S
Gate Resistance	R_G	$V_{GS}=0V, V_{DS}\text{ Open}, f=1\text{MHz}$	-	1.6	-	

Dynamic Characteristics

Input Capacitance	C_{iss}	$V_{GS}=0V, V_{DS}=50V, f=1\text{MHz}$	-	840	-	pF
Output Capacitance	C_{oss}		-	147	-	
Reverse Transfer Capacitance	C_{riss}		-	4.9	-	
Total Gate Charge	$Q_g(10V)$	$V_{DD}=50V, I_D=15A, V_{GS}=10V$	-	16	-	nC
Total Gate Charge	$Q_g(4.5V)$		-	9	-	
Gate to Source Charge	Q_{gs}		-	3	-	
Gate to Drain (Miller) Charge	Q_{gd}		-	3	-	
Turn on Delay Time	$t_{d(on)}$	$V_{DD}=50V, I_D=15A, V_{GS}=10V, R_G=10\text{ }\Omega$	-	6	-	ns
Rise time	t_r		-	3	-	
Turn off Delay Time	$t_{d(off)}$		-	13	-	
Fall Time	t_f		-	3	-	

Reverse Diode Characteristics

Diode Forward Voltage	V_{SD}	$V_{GS}=0V, I_F=20A$	-	0.9	1.2	V
Reverse Recovery Time	t_{rr}	$V_R=50V, I_F=15A, dI_F/dt=500A/\text{s}$	-	30	-	ns
Reverse Recovery Charge	Q_{rr}		-	105	-	nC

Fig 1. Typical Output Characteristics

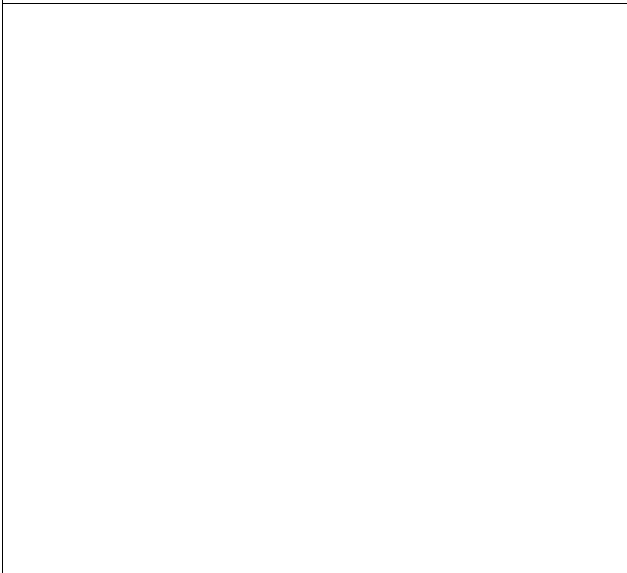

Figure 2. On-Resistance vs. Gate-Source Voltage

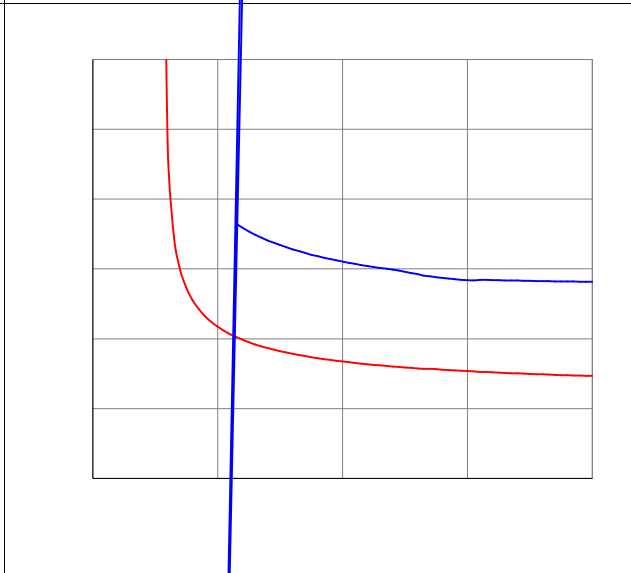

Figure 3. On-Resistance vs. Drain Current and Gate Voltage

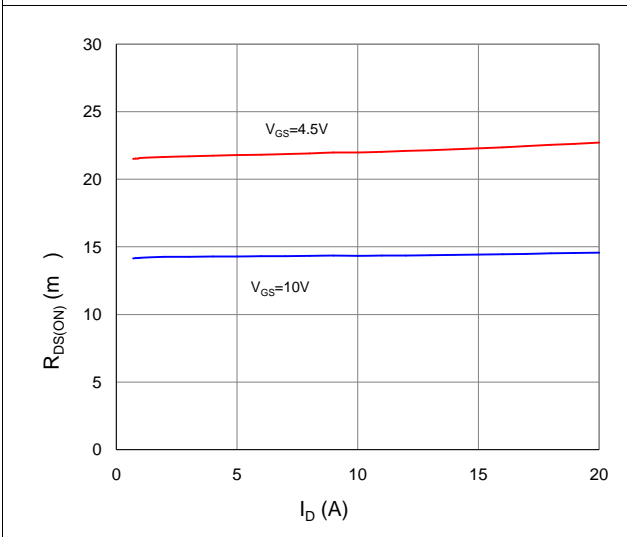

Figure 4. Normalized On-Resistance vs. Junction Temperature

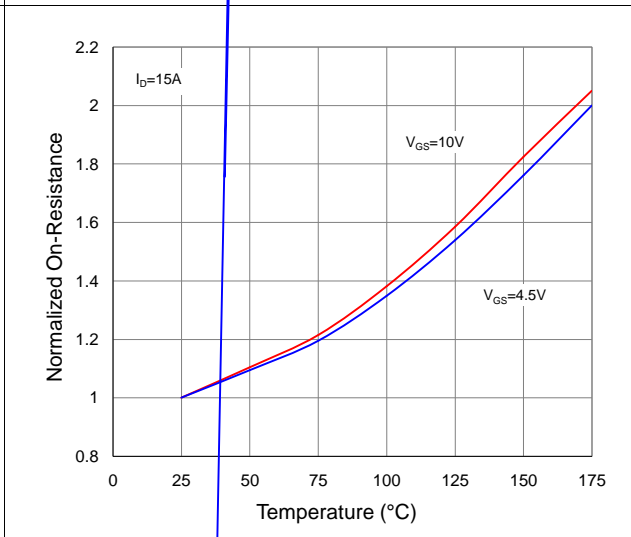

Figure 5. Typical Transfer Characteristics

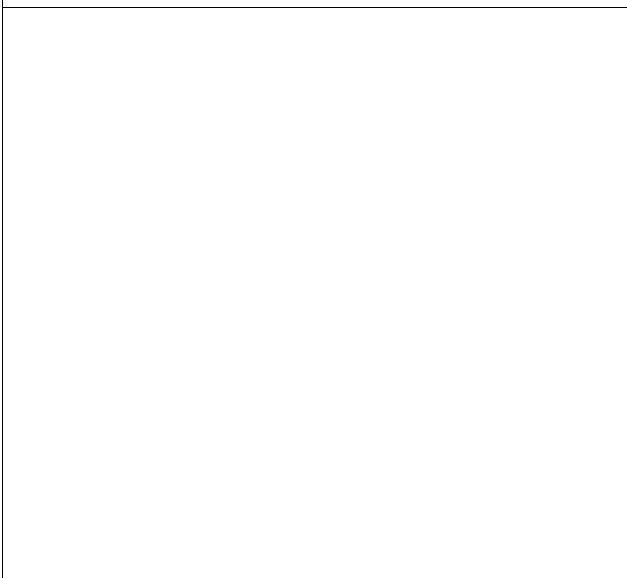

Figure 6. Typical Source-Drain Diode Forward Voltage

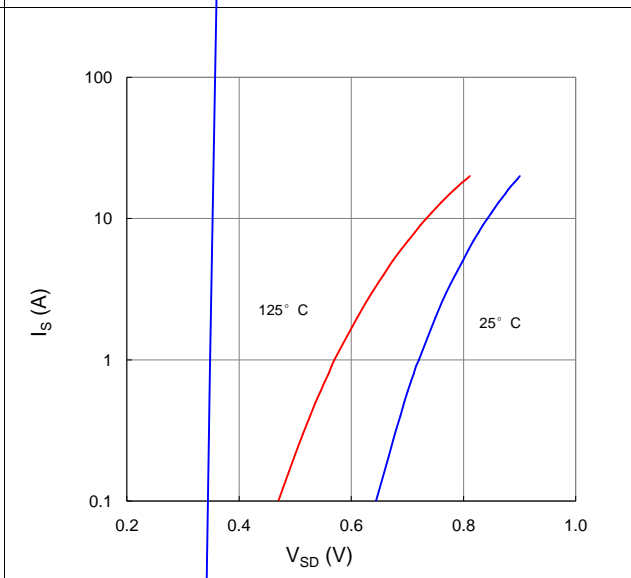

Figure 7. Typical Gate-Charge vs. Gate-to-Source Voltage

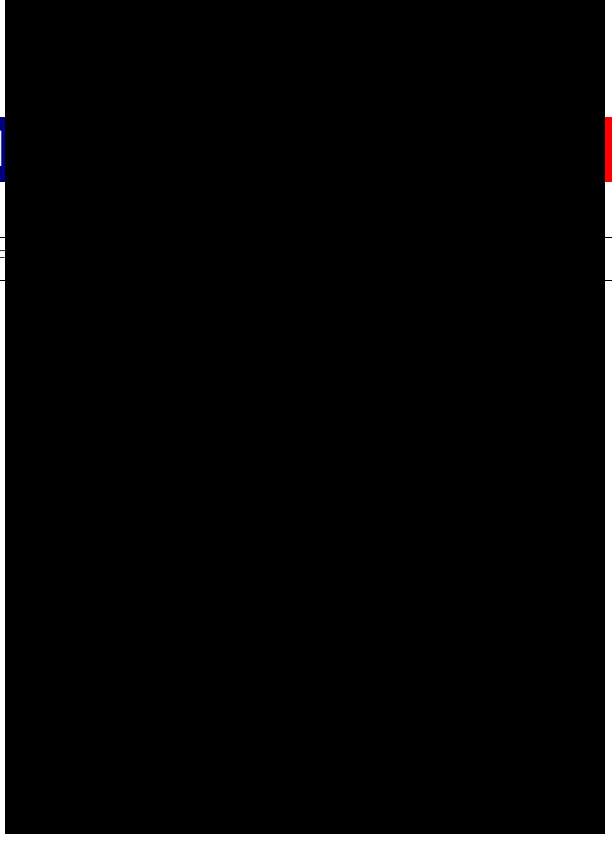
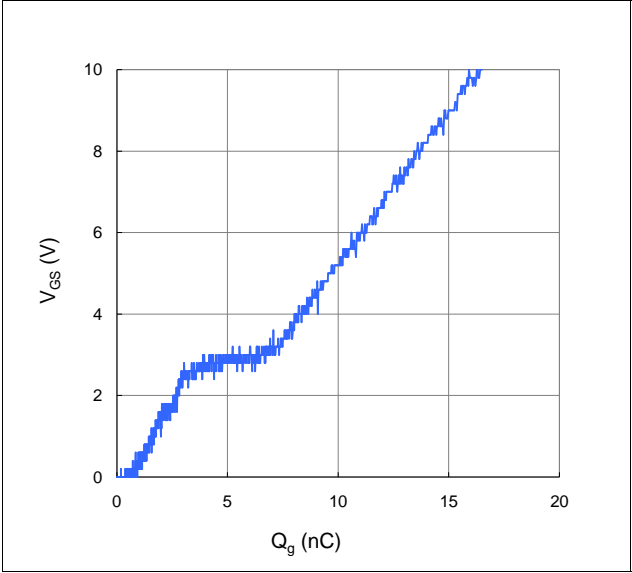

Figure 9. Maximum Safe Operating Area

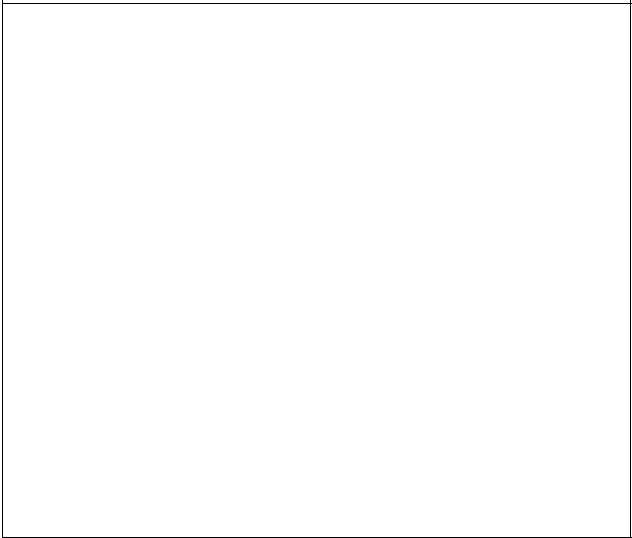

Figure 10. Maximum Drain Current vs. Case Temperature

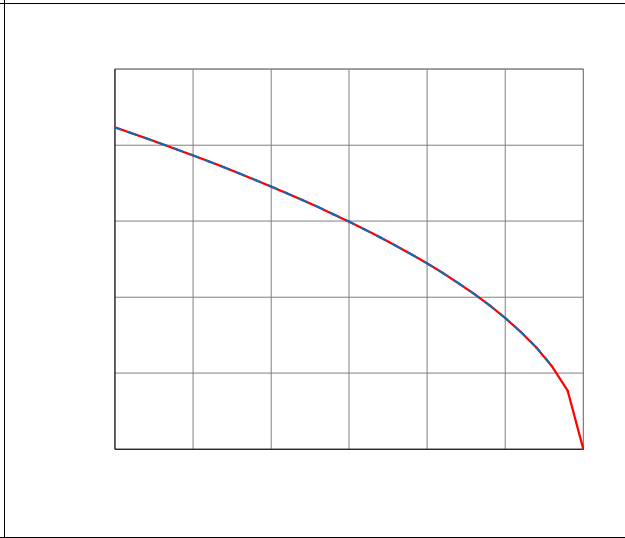
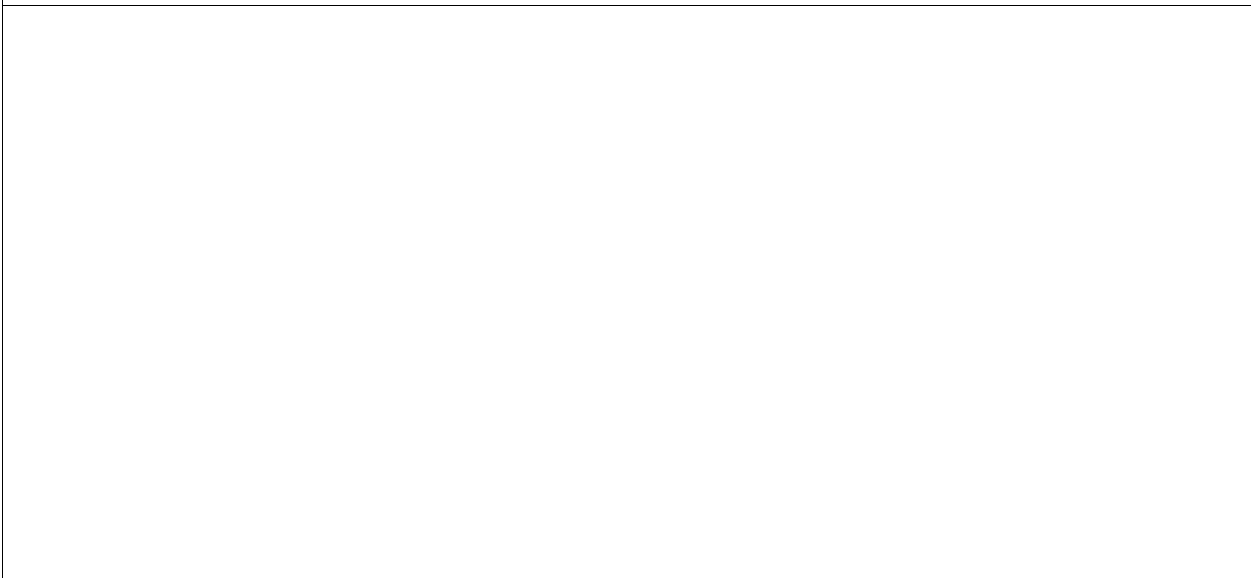
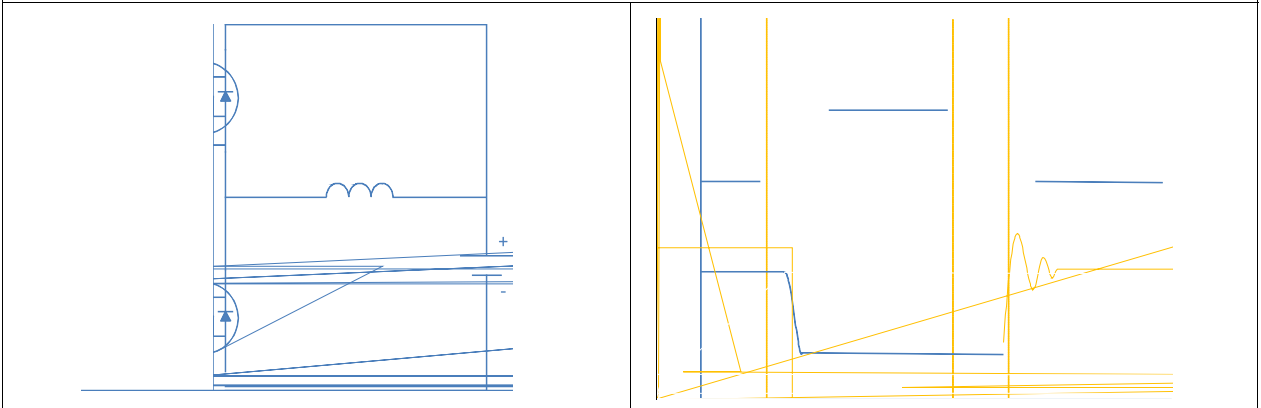

Figure 11. Normalized Maximum Transient Thermal Impedance, Junction-to-Ambient



Inductive switching Test



Gate Charge Test

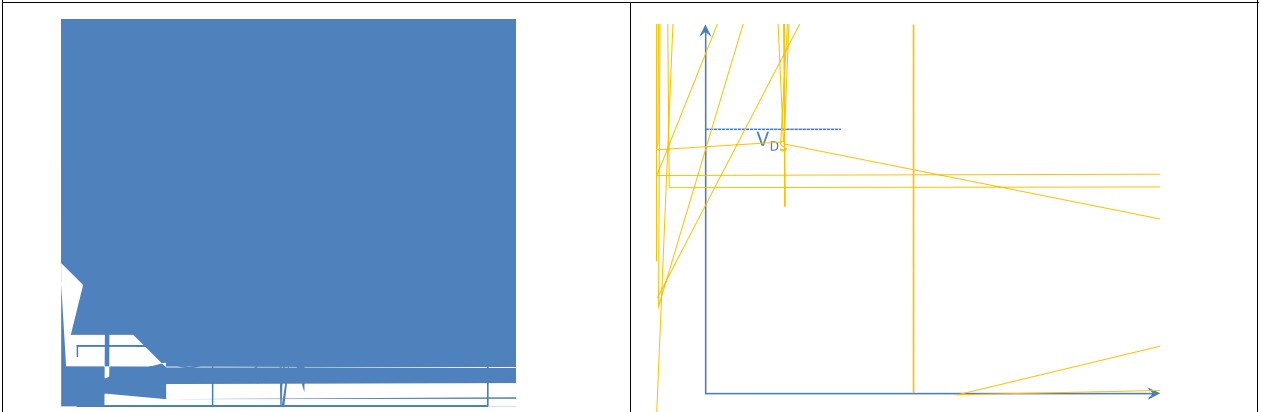

Uclamped Inductive Switching (UIS) Test

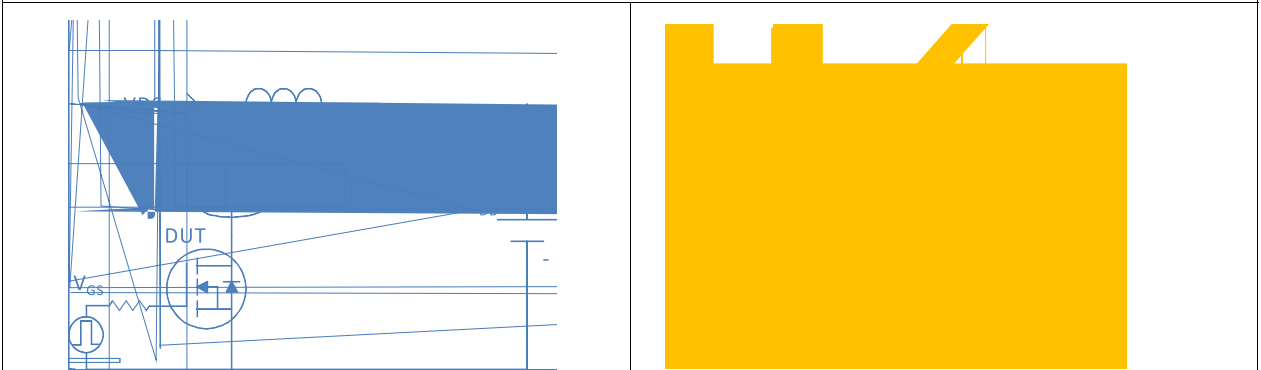

Diode Recovery Test

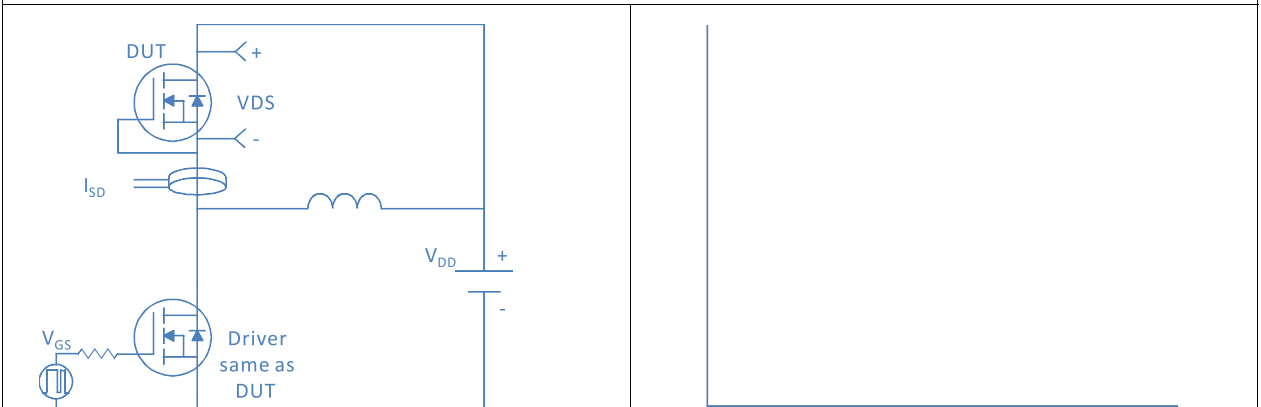

Package Outline

TO-252, 2 leads

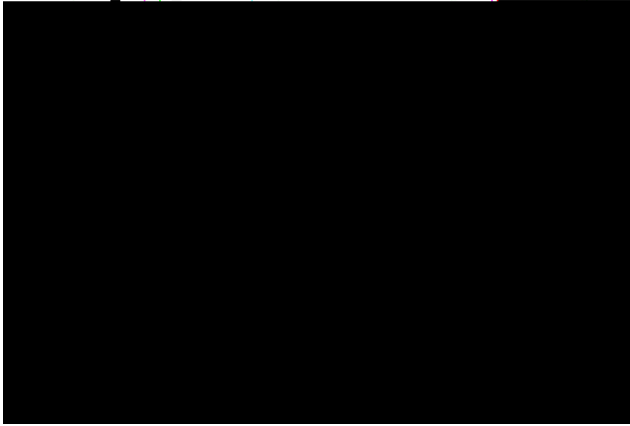

SYMBOL	DIMENSIONAL REQMTS		
	MIN	NOM	MAX
E	6.40	6.60	6.731
L	1.40	1.52	1.77
L1	2.743 REF		
L2	0.508 BSC		
L3	0.89	--	1.27
L4	0.64	--	1.01
L5	--	--	--
D	6.00	6.10	6.223

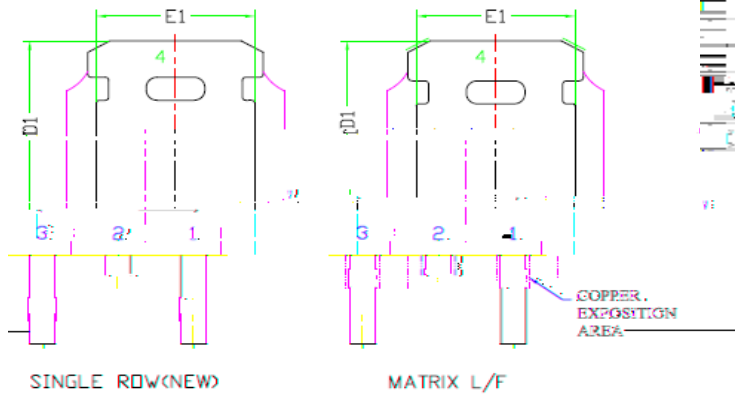

Package Outline

TO-251, 3leads

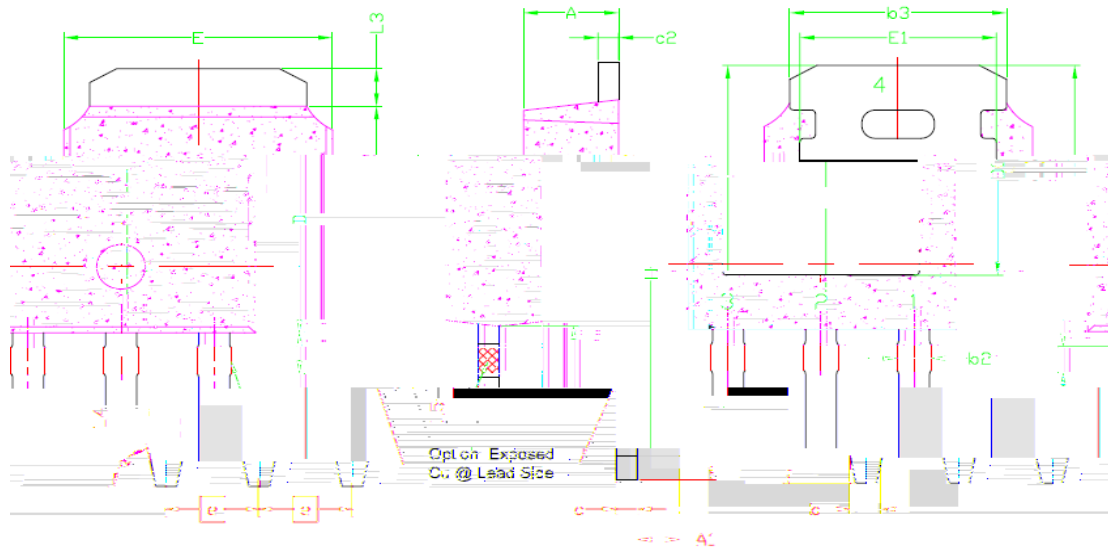

SYMBOL	DIMENSIONAL REQMTS		
	MIN	NOM	MAX
E	6.40	6.60	6.731
L	3.98	4.13	4.28
L3	0.89	--	1.27
L4	0.698 REF		
L5	0.972	1.099	1.226
D	6.00	6.10	6.223
H	11.05	11.25	11.45
b	0.64	0.76	0.88
b2	0.77	0.84	1.14
b3	5.21	5.34	5.46
e	2.286 BSC		
A	2.20	2.30	2.38
A1	0.89	1.04	1.15
c	0.46	0.50	0.60
c2	0.46	0.50	0.60
D1	5.10	--	--
E1	4.40	--	--
a	79° REF		